



International Journal of Engineering Research and Science & Technology

ISSN : 2319-5991
Vol. 4, No. 1
February 2015



www.ijerst.com

Email: editorijerst@gmail.com or editor@ijerst.com

of investigations of influence of intake air temperature on start (Rao, 2011), consumption (Sekaran, 2011) and engine's exhaust emission with direct injection (Broatch, 2010). Extensive researches have included several local producers and at the same time have been done more detailed analysis during the design (Bracanović et al., 2011) and construction work on the heater in diesel engines (Tomić, 2005).

Due to the need of high quality, efficient and simpler tests of heater in diesel engine (Fathollahzadeh et al., 2011) were implemented as a new mechatronic system (Turqueti et al., 2010), for laboratory testing (Advantech, 2001). Designed measuring mechatronic system (Grozđanić et al., 2012) defined the use of sensors for measuring of physical quantities (Karthikeyan et al., 2011) and appropriate conditioners, so as to achieve smooth communication with a PC (Bracanović et al., 2012). Formed on the basis of the algorithm (Grozđanić et al., 2013) with the assistance of computers, it is possible to continuously archive the data during laboratory testing (Advantech, 2001), of the heater engines in diesel (Smith, 2001). It was performed the adaptation of the intake manifold of diesel engines, in order to observe the shape and length of the flame heater in diesel engines (Ogbonnaya, 1998). In the intake manifold of diesel engines were installed three adapters for temperature transducers (Drdarević, 1999) which are used for monitoring temperature gradient (Advantech, 2006), increase along the intake manifold (Stanković, 1997). Implementation of the new mechatronic system to service the laboratory test parameters of heaters in diesel engine with support PCs, has made possible the implementation of various mathematic analysis (Andrew, 2011) of the results.

On the basis of extensive research in the laboratory of different types of heaters, diesel engines (Subramanian, 2011), monitoring and development of methods (Bracanović et al., 2011) for identification of certain physical processes, numerous analyzes (Hodžić, 1989) were included and it was offered the relevant conclusions of the assessment of quality and reliable operation of the heater in diesel engines as well as suggestions for improvement or innovation of the same. In the paper it will be presented a part of the above-mentioned researches related the testing and analysis and results (Aničić, 2006) of the observed heaters in the conditions when different types of the fuel are applied.

MATERIALS AND WORK METHODS

The measurement system designed at the Institute of Motor Industry Rakovica was implemented to establish continuous monitoring (Douglas, 2007) and surveillance monitoring (Peng et al., 2008) of all relevant parameters (Rao, 2011) of the heater in diesel engines (Broatch, 2010). It was very important that the designed measurement system allows to perform tests to identify all the required functional characteristics specified by the manufacturer of diesel engines (Sekaran, 2011). Functional characteristics are defined by the heater manufacturer of diesel engines, in our case the Motor Industry Rakovica from Belgrade, and they are basically shown in Table 1.

In addition to these technical and functional characteristics, special attention is given to the reliable and efficient operation of the heater in real operating conditions over a long period of work of the respective diesel engine.

Table 1: Technical Requirements and Criteria for Evaluating the Quality of the Heater

Specifications for Diesel Motor Heaters		
Supply voltage heater	U(V)	12
The ambient temperature	$\theta_a(^{\circ}\text{C})$	16 ÷ 20
Fuel pressure column	P (bar)	0,3
Fuel	Diesel	
Technical criteria for assessing the quality of diesel engine heater		
Time ignition heater	$t_p(\text{s})$	≥ 14
Current strength heater	I(A)	12 ÷ 13,4
Fuel flow heater	V (mil/min)	3,5 ÷ 5,5
heater stiffness	Leakage prevention: smoke, fuel, air.	
flame shape heater	Strong, regular, little injector combustion	

Adaptation of the Intake Manifold of Diesel Engine

As previously stated, for the purposes of these studies, a special criterion is determined for assessment that defines the shape and length of the flame in the inlet manifold (Bracanović et al., 2011). In this regard, there was an adaptation of diesel engine air intake manifold which can be seen in Figure 1. Opening in the intake manifold is covered with tempered glass, which is resistant to high temperatures. Glass is glued using a special adhesive also resistant to high temperatures. With this adaptation of the intake manifold of diesel engine during laboratory tests was enabled the visual appearance of the flame (by camera or a video camera) in the heater essential for assessing the quality of the heater in diesel engines (Tomić, 2005).

At the same time the intake manifold of the observed four cylinder diesel engines are set corresponding adapters for mounting three sensors for measuring the temperature

(Fathollahzadeh et al., 2011) on three positions, as can be seen in Figure 2.

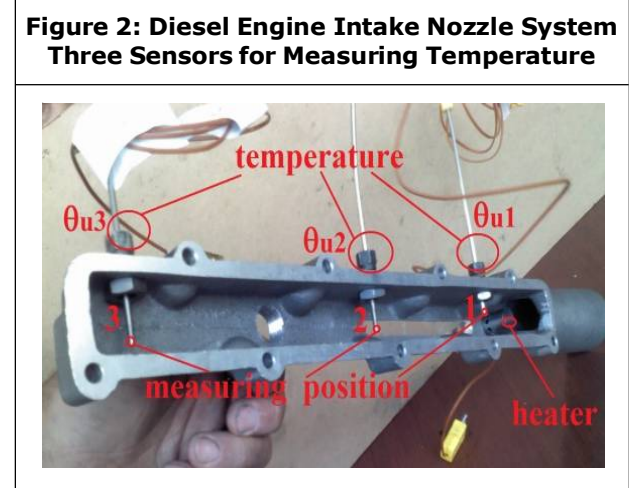
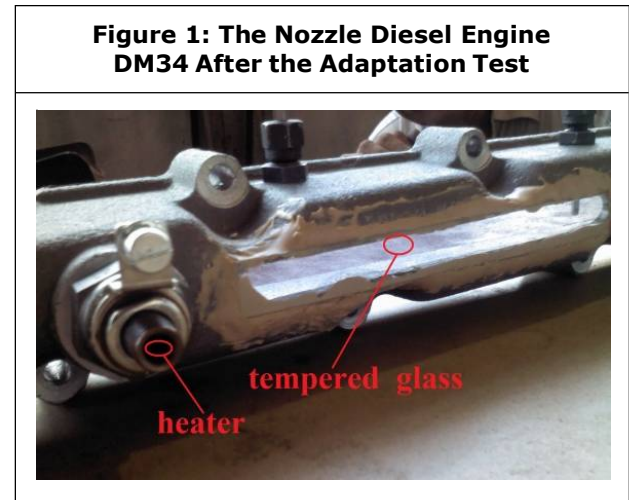

On the first position is measured temperature value of $\theta_{u1}^{\circ}\text{C}$ at the heater and at the first cylinder. At the second position is measured temperature $\theta_{u2}^{\circ}\text{C}$, which is in the direction of the second and third cylinder of diesel engine. Third position is designed to measure the temperature $\theta_{u3}^{\circ}\text{C}$ and in the direction of the fourth cylinder of diesel engine. Prescribed and applied methodology for testing the heater in diesel engines during the laboratory research (Turqueti et al., 2010) asked for observing and notifying of the following parameters: the time of the flame appearance t_p (s) that is the time of the switching on of the heater:

time of flow of the second and the third milliliter of the fuel $t_2(s)$ i $t_3(s)$; temperatures in the intake manifold of the diesel engine $\theta_{u1}^{\circ}C, \theta_{u2}^{\circ}C, \theta_{u3}^{\circ}C$, ambient temperature $\theta_a^{\circ}C$ and fuel temperature $\theta_f^{\circ}C$.

Block Diagram of the Test for Heater in Diesel Engine in Laboratory Conditions

Figure 3 is displaying the block diagram for laboratory research of heater in diesel engine, with marked measuring values, modules for communication with a PC and the main line to generate the data (Advantech, 2001).

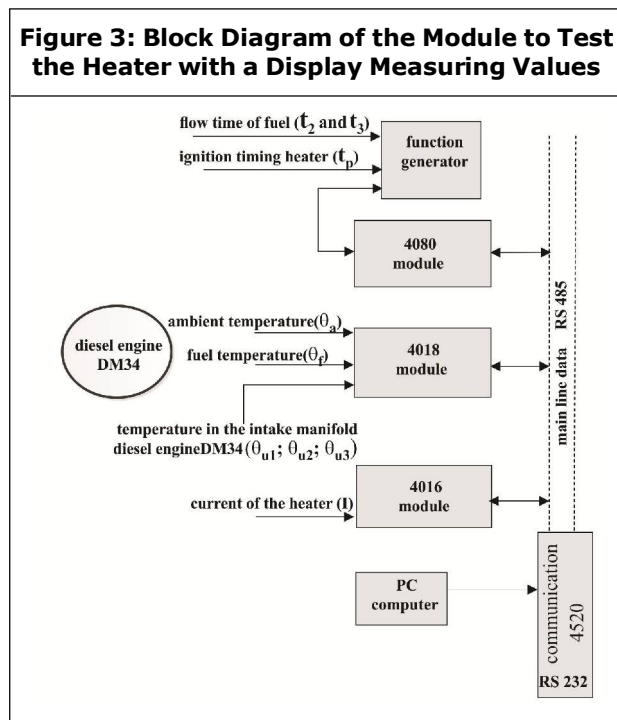

After that we can see basic characteristics of some parts of measuring system.

- Function generator /MA3733/ is a source of AC voltage possible forms: sine, triangular and rectangular. Harmonic distortion the sinusoidal forms of signal: 10 Hz to 50 kHz \pm 2% and 50-100 kHz \pm 3%. Associated attenuators: -20 dB +1dB and the accuracy of the output frequency / \pm 5% for set value.

- Signal conditioner /ADAM 4080/ has two independent counting and frequency measuring entrances where arrives the procession of rectangular frequency modulated pulses. Each of these counters is linked to the input signal via the TTL level. Completely configure operation performs the commands from the PC.
- Communications RS-485/232: This is a bidirectional communication of data using two lines. Connecting the module to the network in a different way through the chaining is achieved through a common line that is main line (Grozdanić et al., 2012). Drivers for communication with any device connected to the network must be set up in the state of receiving or delivery.
- Communication RS-232C is a standard interface to connect the PC and peripheral devices. For this test is applied a synchronous serial data transmission which means that the transmission of data takes place in blocks. Due to its simplicity, resistance and aversion to noise, data speed, it is very easy to use it in industry .
- Signal conversion A/D in conditioners ADAM-4016/4018/ is used to transform the analog signal which is continuous in time in a discrete digital coded signal. Such a signal is further processed by a given program internally in the conditioner but also in the PC.
- A module for conversion of signal ADAM-4520 Advantech serves as a liaison between the conditioner or module for receiving and processing of digital signals that communicate on the basis of the main line RS 485 on one side and a PC with a RS-232C connector on

the other. Module ADAM-4520 performs the necessary signal conversion in the system.

- Thermocouple probe type K for measuring fuel temperature, ambient or intake air of diesel engines. Thermal probes are type K, of Ni-Ch, Ni-Al and it is commonly used in industrial conditions. Thermocouple is in the probe. The length of the probe is 0.3 (m) and diameter is 3×10^{-3} (m).

Specified components of the system are used for complex and proper monitoring (Bracanoviæ et al., 2012). Figure 4 shows a block diagram of a digital measuring-acquisition system for the relevant application (Karthikeyan et al., 2011).

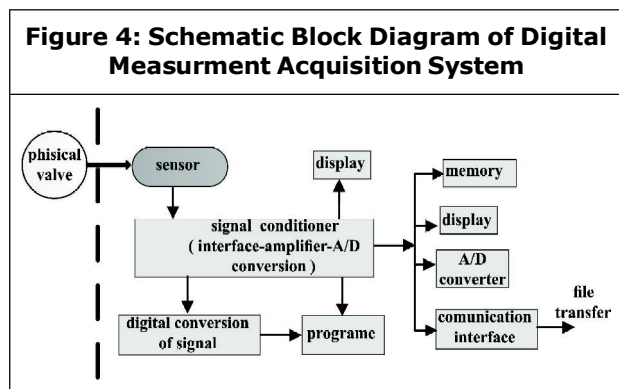

Elements of measurement acquisition systems with communication by the master PC (Grozđanić et al., 2013), provided the filing and processing of complex data, as well as the possibility of programming and modification of input parameters during the laboratory test (Advantech, 2001) of heater diesel engines.

Algorithm Structure of the Program for Acquisition of Measurement Values During the Heater Testing

Algorithm or software program connects hardware structure measuring and controlling the system of the conditioner to the PC with its acquisition card. Software plays a key role in the

development of a system for automated data acquisition and automatic control (Ogbonnaya, 1998). The quality and flexibility of the software used in the development of specific instrumentation system to a great extent defines its overall quality and usefulness.

Way of programming is such that uses finished module or functional blocks. By simple graphical blocks was created the final applicational unit and is defined by data flow from block to block. Set and selected blocks are mutually connected according to the given algorithm (Smith, 2001). Algorithmic structure of the selected program for the acquisition (Drndarević, 1999) of measured values is shown in Figure 5.

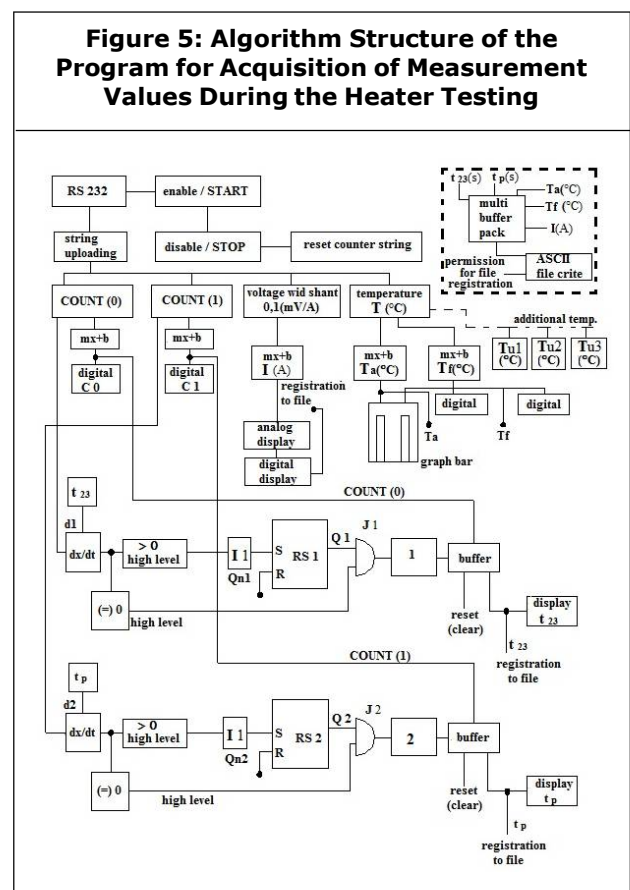

The complexity of the methodology of testing and a number of influential factors on the

operation of the heater in diesel engine in laboratory conditions, led to the complex structure of the algorithm by which is monitored the size of metrology and process control in the laboratory. Initial processing of sensor signals which represents the change in the physical size, is done in the very conditioners. Depending on the type of conditioner, configuration of the required algorithm (Advantech, 2006) involves setting speed mass-communication between the PC and the measuring ADAM modules.

Beginning of the program starts continuous reading data from RS232 port, as shown in Figure 5. Whole algorithm and system for data acquisition consist of a series of mathematical (Stanković, 1997) blocks. Series data and strings are first demultiplexed in the block icon */string unpack/*. Extracted data arriving, are directed towards the blocks */count 0/* and *v /count 1/*, where the signal is converted to numerik. Each of the scales measuring physical quantities are scaled in blocks */mX+B/*. The Time is buffered in memory of PC with blocks */buffer 1/* and */buffer 2/*. Each of the measured physical quantities can be displayed graphically, digitally, in analog way or on bar-graph diagram. Information about the physics of anyone using block sizes */multi buffer pack/* is remembered as */Single ASCII file/* on the hard disk PC. Each of the data is packed into a block */Pack/* with ordinal numbers. During the processing of the measurement is performed downloading of data in of multi-channel buffer, with ordinal numbers under which registration was performed. Serial numbers of the input data */buffer/* represent the column */ASCII file/*.

RESULTS AND DISCUSSION

During the testing of two different diesel fuels, were used two samples of the heater from the

same manufacturer. Each sample heater was started five times. Table 2, gives an overview of part of the results of the measured temperature (Andrew, 2011) of the intake air in the intake manifold of diesel engine of manufacturer DM34 IMR for some samples of the heater, using the bio-diesel from palm oil.

Table 2: Temperature in the Intake Manifold Diesel Engine DM34 Using the Bio-diesel from Palm Oil

Sample Heater	Switching Diesel Engine	$\theta_{u1}(^{\circ}\text{C})$	$\theta_{u2}(^{\circ}\text{C})$	$\theta_{u3}(^{\circ}\text{C})$
1	1	146	138	109
	2	142	135	104
	3	143	135	106
	4	147	136	107
	5	142	133	104
2	1	157	129	122
	2	156	128	123
	3	154	127	124
	4	158	129	124
	5	154	126	123
10	1	134	90	52
	2	134	91	51
	3	136	89	52
	4	134	91	51
	5	133	89	52

During testing of the heater built into the diesel engine, which uses as a fuel bio-diesel from palm, it was followed the shape and length of the flame heater. The respective recording of flame heaters in the intake pipes of diesel engine is shown in Figure 6.

Results of the measured temperature of the intake air in the intake manifold diesel engine

Figure 6: Propagation Flame Heaters in the Intake Pipes of Diesel Engines DM34 with Bio-diesel Palm Oil



Figure 7: Propagation Flame Heaters in the Intake Pipes of Diesel Engines DM34 with Euro Diesel



DM34, using euro diesel fuel are shown in Table 3, which relates to the same sample heater.

Table 3: Temperature in the Intake Manifold Diesel Engine DM34 Using Euro Diesel

Sample Heater	Switching Diesel Engine	$\theta_{u1}(^{\circ}\text{C})$	$\theta_{u2}(^{\circ}\text{C})$	$\theta_{u3}(^{\circ}\text{C})$
1	1	182	149	137
	2	180	147	138
	3	179	147	138
	4	184	149	139
	5	178	150	139
2	1	184	131	128
	2	187	133	129
	3	185	132	128
	4	180	130	126
	5	183	131	127
10	1	212	143	136
	2	215	146	134
	3	217	145	134
	4	215	145	135
	5	218	146	136

Video format and length of the flame heater diesel engines in use euro diesel is shown in Figure 7.

Due to the nature of the measured values of the intake air temperature (Subramanian, 2011) at three measuring positions in the inlet manifold diesel engine DM34 (Bracanović *et al.*, 2011), treatment was only possible by methods of probability and statistics. The density distribution of the observed values for temperatures in the inlet manifold of diesel engine DM34 was done for three measuring positions in the inlet manifold of the respective diesel engine (Hodžija, 1989). It is used Weibull's distribution as a functional dependence based on the formula (1):

$$f(\theta) = \left(\frac{\beta}{\eta}\right) \left(\frac{\theta}{\eta}\right)^{\beta-1} e^{-\left(\frac{\theta}{\eta}\right)^{\beta}} \dots(1)$$

To analyze the measured values of the temperature θ_{u1} , θ_{u2} and θ_{u3} in the inlet manifold of diesel engine, there measured values of odnod temperatures should be enter in a probabilistic paper. By Approximation of straight line between the entered points, parameters of the Weibull distribution (Aničić, 2006) are determined, namely: the shape parameter β and scale parameter η . Thus obtained results were verified for the three measurement positions in the inlet manifold of diesel engines, and are presented in Table 4.

Table 4: Parameters Weibulls Temperature Distribution of Air in the Intake Manifold Diesel Engine DM34 with Different Fuel

Measure Position	Parameters Wejbull's	Bio-diesel from Palm oil	Euro Diesel
/1/	β	7	13
	η (°C)	142	201
/2/	β	3,8	7
	η (°C)	115	160
/3/	β	1,8	10,5
	η (°C)	87	144

Figure 8 provides an overview diagram where the density distribution of temperatures according to Weibull-in is presented (and to) the first measurement position in the inlet manifold of diesel engine DM34. Medium temperature, as can be seen, with the use of euro diesel is $\eta = 201^\circ\text{C}$ and bio-diesel from palm trees, is $\eta = 142^\circ\text{C}$. Clearly, at this measurement position medium air temperature for 41.54% is higher in eurodiesel use in relation to the use of bio-diesel from palm oil material was taken from the same part of a barren.

Figure 8: The Density Distribution for Air Temperature θ in the Intake Manifold of the Diesel Engine

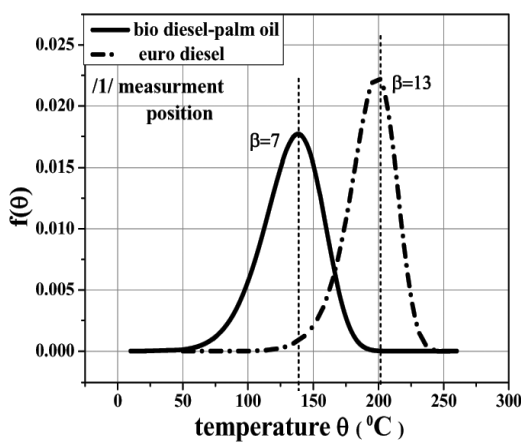
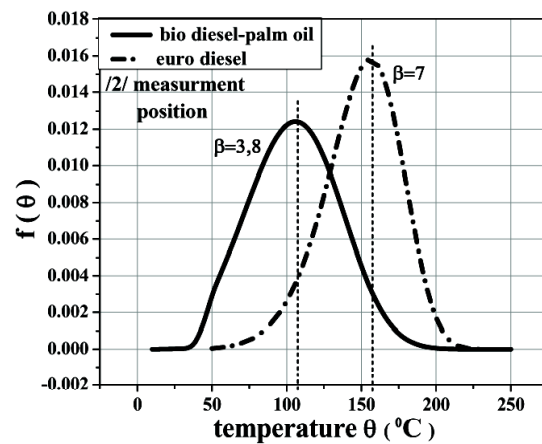

Figure 9 provides an overview of the diagram at which the starch and distribution temperature are presented according to Weibull, and on the second measurement position in the inlet manifold of diesel engine DM34.

Figure 9: The Density Distribution for Air Temperature θ in the Intake Manifold of the Diesel Engine



Medium temperature with the use of euro diesel is $\eta = 160^\circ\text{C}$ and in the use of bio-diesel from palm oil $\eta = 115^\circ\text{C}$. It is clear that the measurement position 2 (s), and the medium temperature of the air is for 39.13% higher using euro diesel in relation to the use of bio-diesel from palm oil.

Figure 10 provides an overview of the diagram at which the starch and the distribution of temperatures are presented, according to Weibull, and on the third position in the inlet manifold of diesel engine DM34.

Medium temperature with the use of euro diesel is $\eta = 144^\circ\text{C}$ and in the use of bio-diesel from palm oil $\eta = 87^\circ\text{C}$. It is clear that the measurement position 3/third/ of the medium air temperature. Is for 65.51% higher in euro diesel use in relation to the use of bio-diesel from palm oil.

Figure 10: The Density Distribution for Air Temperature θ in the Intake Manifold of the Diesel Engine

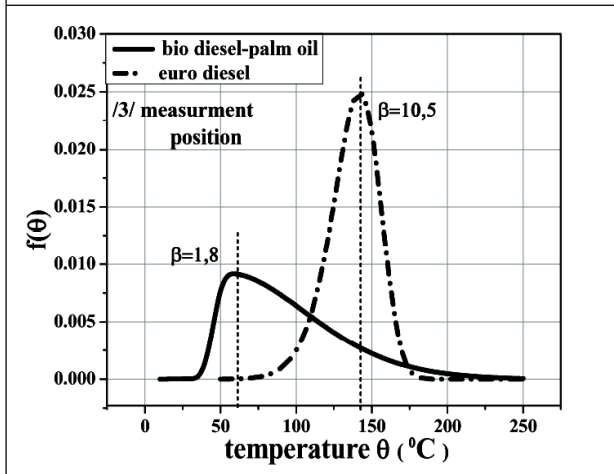

By a Weibull distribution are obtained the results of a high level of trust and on the basis of the presented results, there can be drawn valid conclusions. It is clearly seen that the shape factor β of Weibull's distribution for all three measurement positions, is extremely high when using euro diesel fuel. In other words, this means that the dispersion values over the determination of the medium value is small enough. When you start the diesel engine DM34, the intake manifold of heater flame is formed in a short time period of $t = 1 \div 3$ (s) which extends along the intake manifold, and it heats the intake air. How will the flame be able to heat the intake air at the measuring position 3(third) in the intake manifold of diesel engines, depends on the severity, duration and length of flame propagation. The heat caused by the short duration of the flame heater is wasted on the walls of the intake manifold and the air constantly flows in the intake manifold to cylinder of diesel engine. These processes can be evaluated as stochastic processes that mostly can be controlled.

Based on the above analyses and processing of the obtained results, it can be safely concluded

that when the heater is used, which is using euro-diesel fuel, intake air temperature drops along the intake manifold to 28.35%. However by using the same heaters but with the use of biofuels from palm oil, temperature drops along the suction pipe for 38.73%.

Such a significant difference in warming the air in the intake manifold when using euro diesel fuel and bio-diesel fuel from palm oil, is interpreted by the fact, that in cases of euro diesel fuel flame diffuse, oblong and forms droplets, while the application of biofuels from palm oil flame is significantly shorter, broad, irregular and focused on warming the walls of intake manifold. So, diffuse, oblong flame shaped droplets heaters intake air more than the walls of the intake manifold, and show the overall results of the measured temperature in all three observed points. Average temperatures for use euro diesel fuel are about 40-65% higher than the level obtained by the intake air temperature with the use of biofuels from palm oil.

CONCLUSION

Research of efficiency of the heater in diesel engine implemented in this work and in the wider project of the Institute IMR shows the following:

- Mechatronic systems with the support and control of PCs for testing the heater diesel engine in laboratory conditions, provide flexibility in the management of instruments, continuous monitoring of measurement functions, and their effective and permanent preservation of data.
- Tests of reliability and safety starting in cold conditions of diesel engine confirmed the previous results. Significant advantage in terms of starting were shown by the heaters

which applied euro diesel fuel in relation to the use of bio-diesel fuel from palm oil.

ACKNOWLEDGMENT

This paper is supported by the project of Technological Development TR-35039, by Ministry of Science and Technology of the Republic of Serbia. Project TR-35039 refers to investigation and application of advanced technology and to system for improvement of ecological, energetic and safety characteristic of local agricultural tractors because of increase of competitiveness in European Union and other.

REFERENCES

1. Advantech (2006), *Adam 4000 series Data Acquisition Modules* .10.3 Edition, Advantech Automation Corporation, Taiwan. <http://www.electronicnews.com.au/companies/advantech>, accessed on 2013-10-15.
2. Advantech (2001), *Total solution for PC-based automation Solution guide*, Vol. 91, Taiwan, <http://www.bb-elec.com/Products/Ethernet-Serial-Servers-Gateways>, accessed on 2014-01-31.
3. Advantech (2001), Configure the ADAM-4000 on a RS-485 network, Taiwan.
4. Andrew N O'Connor (2011), "Probability Distributions Used in Reliability Engineering", University of Maryland, College park, Maryland, USA.
5. Aničić V I (2006), "Processing of measurements results", 3rd Edition, Physically University of Belgrade, Serbia.
6. Bracanoviæ Z and Vukas S (2011), "Re-engineering of electrical equipment on tractors", 14th *International conference on quality managing and reliability*, pp. 539-543.
7. Bracanović Z, Grozdanić B and Petrović V (2012), "Contribution to research the validity of diesel engines", *Techniques*, Vol. 37, No. 1, pp. 71-76.
8. Bracanović Z, Grozdanić B and Petrović V (2011), "Mechatronic systems for laboratory testing diesel engine heater", *Journal Modern agricultural technique*, Vol. 37, No. 3, pp. 315-324.
9. Broatch A, Ruiz S, Margot X and Gil A (2010), "Methodology to estimate the threshold in-cylinder temperature for self-ignition of fuel during cold start of diesel engines", *Energy*, Vol. 35, pp. 2251-2260.
10. Drndarević V (1999), *The acquisition of measurement data using a personal computer*, Publisher institute nuclear examination in Vinca, Belgrade, Serbia.
11. Douglas E M (2007), "Monitoring of the Piston Ring Pack and Cylinder Linear Interface in Diesel Engines Through Acoustic Emission Measurements", *Department of Mechanical Engineering, School of Engineering and Physical Sciences*, Harriot Watt University, pp. 8-15.
12. Fathollahzadeh H, Mobli H, Jafari A, Mahdavinejhad D and Tabatabaie S M H (2011), "Design and calibration of a fuel consumption measurement system for a diesel tractor", *Agricultural Engineering International: the CIGR Journal Manuscript*, Vol. 13, No. 1408, Issue 2, pp. 512-525.
13. Grozdanić B, Grozdanić Z, Petrović V and Bracanović Z (2012), "Acquisition program of graphic oriented programming", 15th

- International conference on quality managing and reliability*, pp. 497-503.
14. Grozdanić B, Petrović V and Bracanović Z (2013), "Mobile devices and its application in agriculture", *1th International symposium on agricultural engineering (ISAE)*, pp. III:21-25
 15. Hodžić O (1989), "Numerical and statistical methods in processing experimental data", 2nd Edition, Mathematics University of Novi Sad, Serbia.
 16. Karthikeyan S, Hariganesh R, Sathyanadan M and Krishnan S (2011), "Computational analysis of EGR mixing inside the intake system & experimental investigation on diesel engine for lcv", *International Journal of Engineering Science and Technology (IJEST)*, Vol. 3, No. 3, pp. 2350-2357.
 17. Ogbonnaya E A (1998), "Condition Monitoring of a Diesel Engine for Electricity", Thesis Department of Marine Engineering, RSUST Port Harcourt, pp. 1-10.
 18. Peng H-Y, Cui Y, Deng H-Y, Shi L and Li L-G (2008), "Combustion and emissions of a direct-injection diesel engine during cold start under different exhaust valve closing timing conditions", *Journal of Automobile Engineering*, Vol. 222, No. 1, pp. 119-129.
 19. Rao P V (2011), "Experimental investigation on the influence of properties of jatropha biodiesel on performance, combustion, and emission characteristics of a Di-Ci engine", *Journal World Academy of Science, Engineering and Technology*, Vol. 75, pp. 855-866.
 20. Sekaran W C M (2011), "Transient state fuel injection-a new concept with different fuel combinations". *Interdisciplinary Research and Development*, pp. 461-467.
 21. Smith R (2001), Quick reference for RS485, RS422, RS232 and RS423, Taiwan, <http://www.rs485.com/rs485spec.htm>, accessed on 2013-11-21.
 22. Stanković D (1997), *Physical and technical measurement sensors*, Publisher of Electrical Engineering University of Belgrade, Serbia.
 23. Subramanian KA (2011), "A comparison of water–diesel emulsion and timed injection of water into the intake manifold of a diesel engine for simultaneous control of NO and smoke emissions", *Energy Conversion and Management*, Vol. 52, pp. 849-857.
 24. Tomić M (2005), "Engine equipment", 5th Edition, Mechanical Engineering University of Belgrade, Serbia.
 25. Turqueti M, Saniie J, and Oruklu E (2010), "MEMS acoustic array embedded in an FPGA based data acquisition and signal processing system", *53rd IEEE International Midwest Symposium on Circuits and Systems (MWSCAS)*, pp. 1161-1164.



International Journal of Engineering Research and Science & Technology

Hyderabad, INDIA. Ph: +91-09441351700, 09059645577

E-mail: editorijerst@gmail.com or editor@ijerst.com

Website: www.ijerst.com

